

New: Eppendorf BioPhotometer® D30  
Eppendorf BioSpectrometer® fluorescence



# Spectracular

Spectracular performance  
Eppendorf photometer and accessories



With the maximum level of flexibility, Eppendorf photometry products are equipped to handle a wide range of applications.

# »Eppendorf continues a long-standing tradition with over 60 years of experience in the field of photometry.«

In 1950, Eppendorf brought its first photometer to the market. From the very beginning, the focus was on obtaining maximum benefits while using the simplest handling methods. This philosophy has remained unchanged to this day. Take advantage of our expertise by achieving optimum results in your laboratory.

## Discover new possibilities

- > The BioSpectrometer fluorescence combines UV/Vis and fluorescence methods
- > Sensitive sample quantification beyond the photometric detection limit
- > The simplest handling and guided method procedures to make your work even easier



## Take advantage of the possibilities

- > Preprogrammed applications for a quick start and minimal errors
- > Automatic evaluation of measurement data and clear presentation of results
- > Direct storage of measurement data in the device prevents loss of data

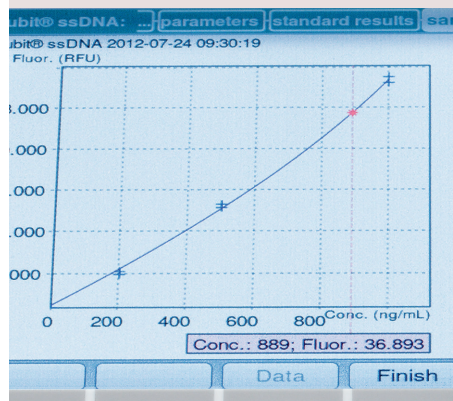

## Expand your possibilities

- > The perfect accessories for all your photometric applications, from UV-transparent plastic cuvettes to a special microliter measuring cell
- > Certified purity grades ensure that valuable sample material is immediately available for further use





Preprogrammed methods, automatic evaluation of measurement data and clear presentation of results

Simplest handling, guided software procedures, and operation directly on the device make your work even easier

## Eppendorf BioSpectrometer® basic

With the Eppendorf BioSpectrometer basic, measurements can be executed in the UV and Vis range from 200 nm to 830 nm. The freely selectable wavelengths offer you maximum flexibility during these procedures.

Optimized menu navigation guides you through the individual methods in a step-by-step process. All required entries are visible right away. The entire operating procedure is guided by a help box that explains each individual step.

### Product benefits

- > UV/Vis spectral range of 200 nm to 830 nm
- > Preprogrammed applications for quick start
- > Guided software procedure and operation directly on the device
- > Automatic storage of measuring results (> 1,000)
- > Integrated data processing option for specific methods

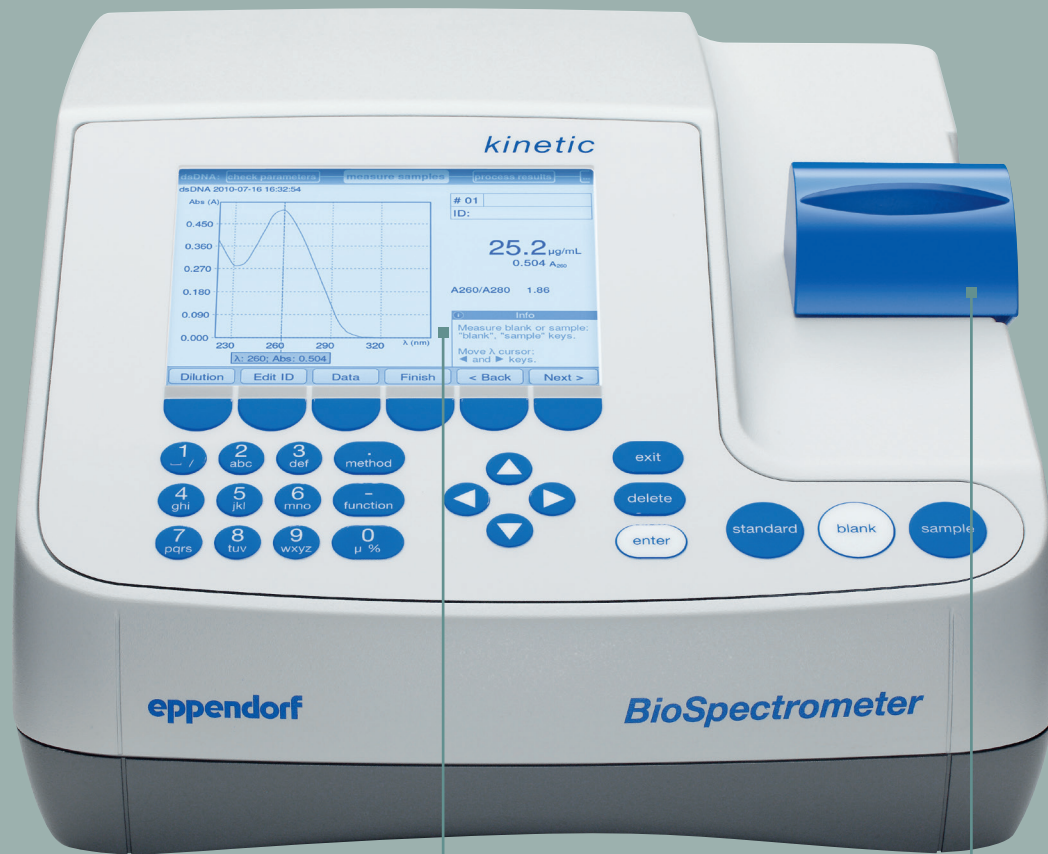

Retrospective modification of the time window for regression analysis with corresponding kinetic methods

Integrated, freely temperature-controlled cuvette shaft for determining enzyme and substrate kinetics

## Eppendorf BioSpectrometer<sup>®</sup> kinetic

As an expansion of the BioSpectrometer basic, the Eppendorf BioSpectrometer kinetic features a temperature-controlled cuvette shaft. The integrated Peltier element guarantees high-precision temperature control.

In addition to the wide range of methods available on the BioSpectrometer basic, the BioSpectrometer kinetic software offers preprogrammed and freely programmable kinetic methods.

### Product benefits

- > All BioSpectrometer basic options
- > Preprogrammed and freely programmable kinetic methods
- > Retrospective modification of the time window for regression analysis
- > Temperature-controlled cuvette shaft (adjustment range +20 °C to +42 °C in 0.1 °C increments)

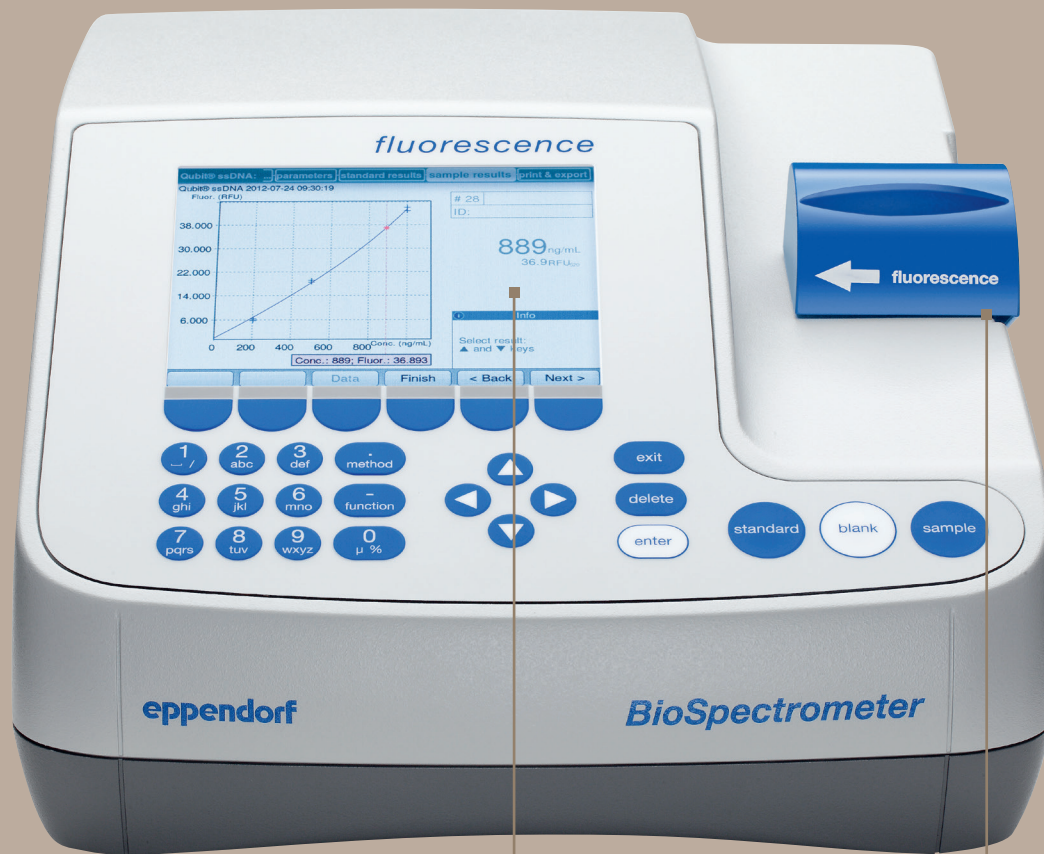

UV/Vis absorption measuring range of 200 nm to 830 nm combined with a fluorescence intensity of 0.5 nM to 2,000 nM fluorescein

Combination of UV/Vis and fluorescence measurements in a single device

## Eppendorf BioSpectrometer® fluorescence

The integrated fluorescence unit of the BioSpectrometer fluorescence can be used to increase the measuring range by a factor of 1,000, for example, to detect DNA. This enables reliable quantification up to a concentration of 1.0 µg/µL.

Measurements can be flexibly executed in the UV/Vis or fluorescence range. What's more, quantifications can be carried out using fluorescence dyes in the same device, even well beyond the photometric detection limit.

### Product benefits

- > All BioSpectrometer basic options
- > Preprogrammed and freely programmable fluorescence methods
- > Fluorescence intensity across a range of 0.5 nM to 2,000 nM fluorescein
- > Fluorescence excitation wavelength 470 nm, emission wavelengths 520 nm and 560 nm



Relevant ratios are automatically determined and displayed

Preprogrammed applications with evaluations via factor, standard or standard series for a quick start

## Eppendorf BioPhotometer® D30

The Eppendorf BioPhotometer D30 is the third generation of Eppendorf's well-established BioPhotometers. The measurement data will be recorded for fixed wavelengths. Small, clearly processed data volumes make evaluating results fast and simple.

For specific methods, additional measurement data will be recorded in a defined measuring range and displayed extrapolated, making impurities in the sample easier and quicker to identify.

### Product benefits

- > Fixed wavelengths at 230 nm, 260 nm, 280 nm, 320 nm, 340 nm, 405 nm, 490 nm, 562 nm, 595 nm and 600 nm
- > Display of purity scans (extrapolated measurement data) for specific applications
- > Preprogrammed applications for a quick start
- > Applications with evaluations via factor, standard or standard series
- > All relevant ratios are automatically determined for a method.

# Eppendorf $\mu$ Cuvette<sup>®</sup> G1.0



With an optical path length of only 1 mm, the  $\mu$ Cuvette G1.0 features a light path that is ten times shorter than the light path on standard cuvettes. This allows high nucleic acid and protein concentrations to be measured using the  $\mu$ Cuvette G1.0. Only 1.5  $\mu$ L of a sample is required for the measurement. The  $\mu$ Cuvette G1.0 offers a flexible expansion of the photometric application range of Eppendorf photometers.

#### Product benefits

- > Microvolume measuring cell for measuring 1.5 –10  $\mu$ L sample volumes
- > Concentration determination of nucleic acids and proteins
- > Measurement of high sample concentrations without prior dilution
- > Exclusively available for Eppendorf BioPhotometer and Eppendorf BioSpectrometer

> Use our cuvette navigator to find the right cuvette for your application:

# UVette<sup>®</sup>

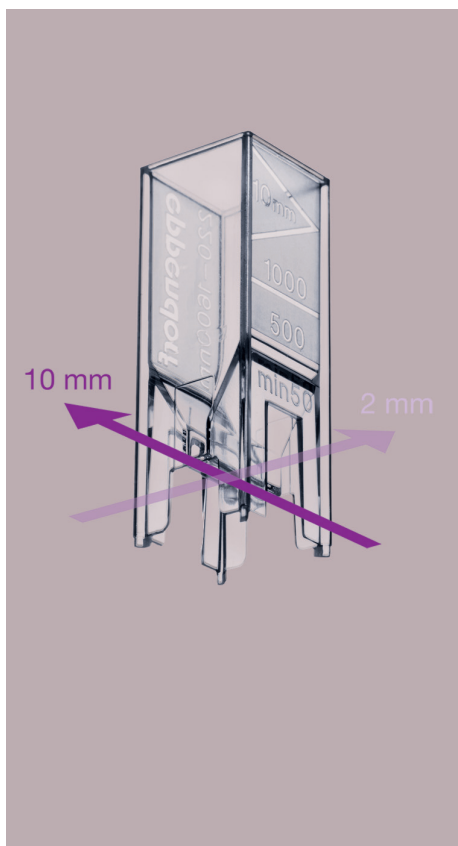

The patented\* Eppendorf UVette is a fully UV-transparent, single use cuvette made of clear plastic, with a light transmission of 220 nm to 1,600 nm. The unique design allows you to conduct flexible measurements with two different light paths (10 mm and 2 mm).

This means that only one cuvette is needed to measure various concentration ranges at a minimum volume of 50  $\mu$ L. To fulfill various requirements in the laboratory, the UVette is available in two purity grades and packaging sizes.

\* U.S. Patent Nr.: 6,249,345

#### Product benefits

- > UV/Vis measurements from 220 to 1,600 nm
- > Concentration determination of nucleic acids, proteins and fluorescence signals
- > Combination of two light paths (10 mm and 2 mm)
- > Also available in certified PCR clean and protein-free quality for sensitive (e.g., RNA) and valuable samples

> Use our cuvette navigator to find the right cuvette for your application:



# Vis Cuvettes

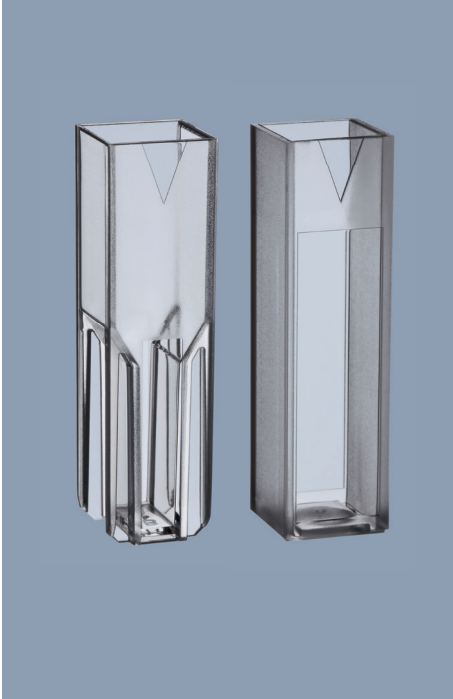

The Eppendorf Vis Cuvettes are disposable cuvettes made of clear plastic with a light transmission of 300 nm to 900 nm.

The Vis cuvettes are the perfect tool for applications outside of the UV range, for example, colorimetric protein assays (Bradford, Lowry, etc.), determining of the optical density of bacterial cultures (OD600 methods), and kinetic and fluorescence measurements.

Based on the volume you would like to measure, you can select a semi-micro or a macro cuvette.

## Product benefits

- > Vis measurements from 300 to 900 nm
- > Suitable for colorimetric protein assays, OD600, and kinetic and fluorescence measurements
- > Two different cuvette sizes (semi-micro and macro) for a wide variety of volumes

> Use our cuvette navigator to find the right cuvette for your application:

# Filter sets



The secondary UV/Vis reference filter set is used to verify the photometric and wavelength systematic errors according to NIST® (National Institute of Standards and Technology, Gaithersburg MD, USA).

The BioSpectrometer fluorescence filter set also verifies the fluorometric precision (random error) and linearity. Filter sets are available for verifying the BioSpectrometer basic and BioSpectrometer kinetic, BioSpectrometer fluorescence and BioPhotometer D30.

## Product benefits

- > Filter traceable to NIST
- > Preprogrammed log for verification in the devices
- > Verification of the photometric precision and accuracy, and fluorometric precision and linearity, in the BioSpectrometer fluorescence

# History



Eppendorf has developed an impressive level of expertise through its contributions to the field of photometry. Eppendorf brought its first photometer on the market over 60 years ago. With its current product portfolio, Eppendorf allows you to select the optimal combination of devices and accessories from a large, rapidly expanding, range of products. From fluorescence-based applications to microvolume measurements: anything is possible!



1950

Photometer »Medeor«:  
Spectrophotometer



1955

Flame photometer  
Eppendorf



1968

Photometer  
1101 and 1102



1972

Digital Photometer  
6114/15



1992

Photometer ECOM 6122



1998

Eppendorf  
BioPhotometer® 6131

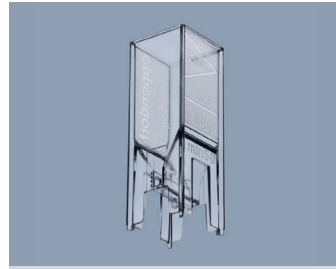

2000

UVette®



2007

Eppendorf  
BioPhotometer® plus



2011

Eppendorf  
BioSpectrometer® basic/kinetic



2012

Eppendorf  
µCuvette® G1.0





2013





Eppendorf  
BioSpectrometer® fluorescence

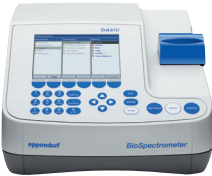
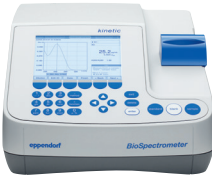
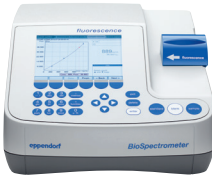

2013

Eppendorf  
BioPhotometer® D30

Technical data of instruments	BioSpectrometer basic	BioSpectrometer kinetic	BioSpectrometer fluorescence	BioPhotometer D30
				
Absorption light source	Xenon flash lamp			
Fluorometer light source	–	–	LED	–
Height of light source	8.5 mm			
Absorption measuring principle	Single-beam absorption spectrophotometer with reference beam			Single-beam absorption photometer with reference beam
Fluorometer measuring principle	–	–	Confocal filter fluorometer with reference beam	–
Absorption beam receiver	CMOS photodiode array			CMOS photodiodes
Fluorometer beam receiver	–	–	Photodiodes	–
Wavelength range absorption	Scan (nm): 200–830 at 1 nm increments			Fixed wavelengths (nm): 230, 260, 280, 320, 340, 405, 490, 562, 595, 600
Fluorometer excitation wavelength	–	–	470 nm, bandwidth: 25 nm	–
Fluorometer emission wavelengths	–	–	520 nm, bandwidth: 15 nm 560 nm, bandwidth: 40 nm	–
Temperature control	–	20 °C to 42 °C at 0.1 °C increments	–	–
Absorption spectral bandwidth	< 4 nm			
Absorption measuring range	0 A–3.0 A (260 nm)			
Fluorometer measuring range	–	–	0.5 nM–2,000 nM fluorescein (emission wavelength 520 nm)	–
dsDNA concentration range	2.5 ng/μL–1,500 ng/μL	2.5 ng/μL–1,500 ng/μL	1.0 pg/μL–1,500 ng/μL	2.5 ng/μL–1,500 ng/μL
Interfaces	USB master: for USB stick USB slave: for connecting to a PC Interface for Eppendorf thermal printer: serial RS 232			
Dimensions (W × D × H)	295 × 400 × 150 mm			
Weight	5.4 kg	5.5 kg	5.4 kg	5.4 kg

Cuvette technical data	Eppendorf μCuvette® G1.0	UVette®	Macro Vis cuvettes	Semi-micro Vis cuvettes
				
<b>dsDNA (UV) concentration range</b>	25 ng/μL–1,500 ng/μL	2.5 ng/μL–750 ng/ μL	–	–
<b>Colorimetric protein assays</b>	✓	✓	✓	✓
<b>OD 600 methods</b>	–	✓	✓	✓
<b>Fluorescence measurements</b>	✓	✓	✓	✓
<b>UV transparency</b>	> 180 nm	> 220 nm	–	–
<b>Light transmission</b>	180 nm–2,000 nm	220 nm–1,600 nm	300 nm–900 nm	
<b>Dimensions (W × D × H)</b>	12.5 mm × 12.5 mm × 48 mm	12.5 mm × 12.5 mm × 36 mm	12.5 mm × 12.5 mm × 45 mm	
<b>Temperature control</b>	–	–	✓	–
<b>Minimum filling volume</b>				
> in Eppendorf photometers	1.5 μL	50 μL	1,000 μL	400 μL
> in devices from other manufacturers	–	50 μL	2,500 μL	1,500 μL
<b>Maximum filling volume</b>	10 μL	2,000 μL	4,500 μL	3,000 μL
<b>Optical path length(s)</b>	1 mm	2 mm & 10 mm	10 mm	
<b>Cuvette blank at 260 nm</b>	< 0.05 A	< 0.5 A	–	–
<b>Height of light source</b>	8.5 mm	8.5 mm (adapters available for height adjustments)	8.5 mm–15 mm	
<b>Use in Eppendorf BioPhotometer</b>	✓	✓	✓	✓
<b>Use in Eppendorf BioSpectrometer</b>	✓	✓	✓	✓
<b>Use in devices from other manufacturers</b>	–	✓ (adapters available)	✓	✓

## Ordering information

Description	Order no. International	Order no. North America
<b>Eppendorf <math>\mu</math>Cuvette<sup>®</sup> G1.0</b> Eppendorf microvolume measuring cell for Eppendorf BioPhotometer <sup>®</sup> and Eppendorf BioSpectrometer <sup>®</sup>	6138 000.018	6138000018
<b>Eppendorf BioPhotometer<sup>®</sup> D30</b> – 230V/50–60Hz, mains plug for Europe, additional mains/power connections available – 120V/50–60Hz, mains plug for North America	6133 000.001 6133 000.010	– 6133000010
<b>Eppendorf BioSpectrometer<sup>®</sup> basic</b> – 230V/50–60Hz, mains plug for Europe, additional mains/power connections available – 120V/50–60Hz, mains plug for North America	6135 000.009 6135 000.017	– 6135000017
<b>Eppendorf BioSpectrometer<sup>®</sup> kinetic</b> – 230V/50–60Hz, mains plug for Europe, additional mains/power connections available – 120V/50–60Hz, mains plug for North America	6136 000.002 6136 000.010	– 6136000010
<b>Eppendorf BioSpectrometer<sup>®</sup> fluorescence</b> – 230V/50–60Hz, mains plug for Europe, additional mains/power connections available – 120V/50–60Hz, mains plug for North America	6137 000.006 6137 000.014	– 6137000014
<b>Eppendorf <math>\mu</math>Cuvette<sup>®</sup> G1.0 &amp; Eppendorf BioPhotometer<sup>®</sup> D30</b> Eppendorf microvolume measuring cell and BioPhotometer D30 – 230V/50–60Hz, mains plug for Europe – 120V/50–60Hz, mains plug for North America	6133 000.907 6133 000.908	– 6133000940
<b>Eppendorf <math>\mu</math>Cuvette<sup>®</sup> G1.0 &amp; Eppendorf BioSpectrometer<sup>®</sup> basic</b> Eppendorf microvolume measuring cell and Eppendorf BioSpectrometer <sup>®</sup> basic – 230V/50–60Hz, mains plug for Europe – 120V/50–60Hz, mains plug for North America	6135 000.904 6135 000.905	– 6135000923
<b>Eppendorf BioPhotometer<sup>®</sup> D30 reference filter set</b> Filter set for verifying photometric accuracy and wavelength systematic error (according to NIST <sup>®</sup> ) in the Eppendorf BioPhotometer <sup>®</sup> D30	6133 928.004	6133928004
<b>Eppendorf BioSpectrometer<sup>®</sup> basic &amp; kinetic reference filter set</b> Filter set for verifying photometric accuracy and wavelength systematic error (according to NIST) in the Eppendorf BioSpectrometer <sup>®</sup> basic and Eppendorf BioSpectrometer <sup>®</sup> kinetic	6135 928.001	6135928001
<b>Eppendorf BioSpectrometer<sup>®</sup> fluorescence reference filter set</b> Filter set for verifying photometric accuracy and wavelength systematic error (according to NIST), fluorimetric precision (random error) and linearity	6137 928.009	6137928009
<b>UVette<sup>®</sup> 220 nm–1,600 nm</b> Plastic cuvette for measurements in the UV and Vis range, individually packaged, certified PCR clean and protein-free, box of 80	0030 106.300	952010051
<b>UVette<sup>®</sup> routine pack 220 nm–1,600 nm</b> Plastic cuvette for measurements in the UV and Vis range, Eppendorf Quality, reclosable box, box of 200	0030 106.318	952010069
<b>Macro Vis Cuvettes 300 nm–900 nm</b> Plastic cuvette for measurements in the Vis range, max. filling volume 4,500 $\mu$ L, 10 $\times$ box of 100	0030 079.345	0030079345
<b>Semi-micro Vis Cuvettes 300 nm–900 nm</b> Plastic cuvette for measurements in the Vis range, max. filling volume 3,000 $\mu$ L, 10 $\times$ box of 100	0030 079.353	0030079353



# WolfLabs

**Pricing on any accessories shown can be found by keying the part number into the search box on our website.**

The specifications listed in this brochure are subject to change by the manufacturer and therefore cannot be guaranteed to be correct. If there are aspects of the specification that must be guaranteed, please provide these to our sales team so that details can be confirmed.

**[www.wolflabs.co.uk](http://www.wolflabs.co.uk)**

**Tel : 01759 301142**

**Fax : 01759 301143**

**[sales@wolflabs.co.uk](mailto:sales@wolflabs.co.uk)**

Please contact us if this literature doesn't answer all your questions.